

Prefeitura Municipal de Ilhéus

Planta de Zoneamento
Uso e Ocupação do Solo
Anexo I - Lei Nº 3746/2015



ESCALA: 1:10.000 DATA: MAIO 2020 FOLHA:

01

Secretaria de Meio Ambiente e Urbanismo

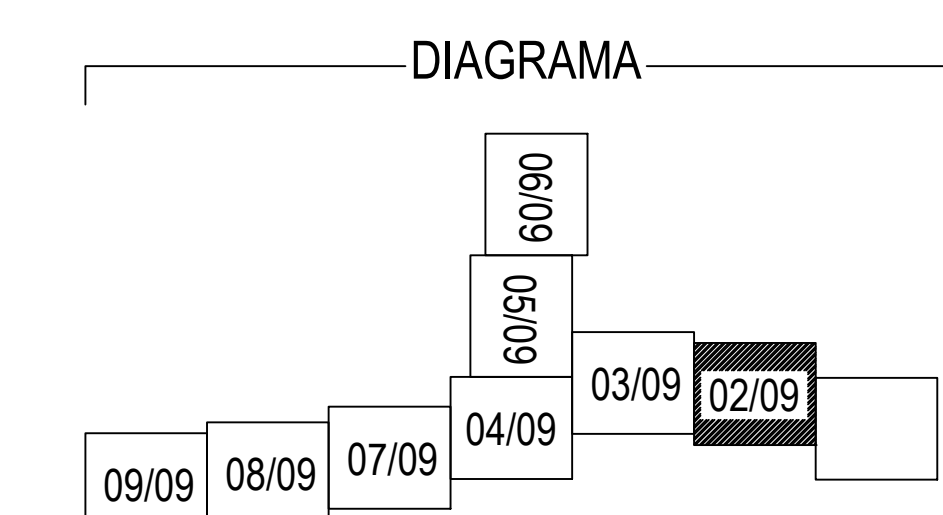
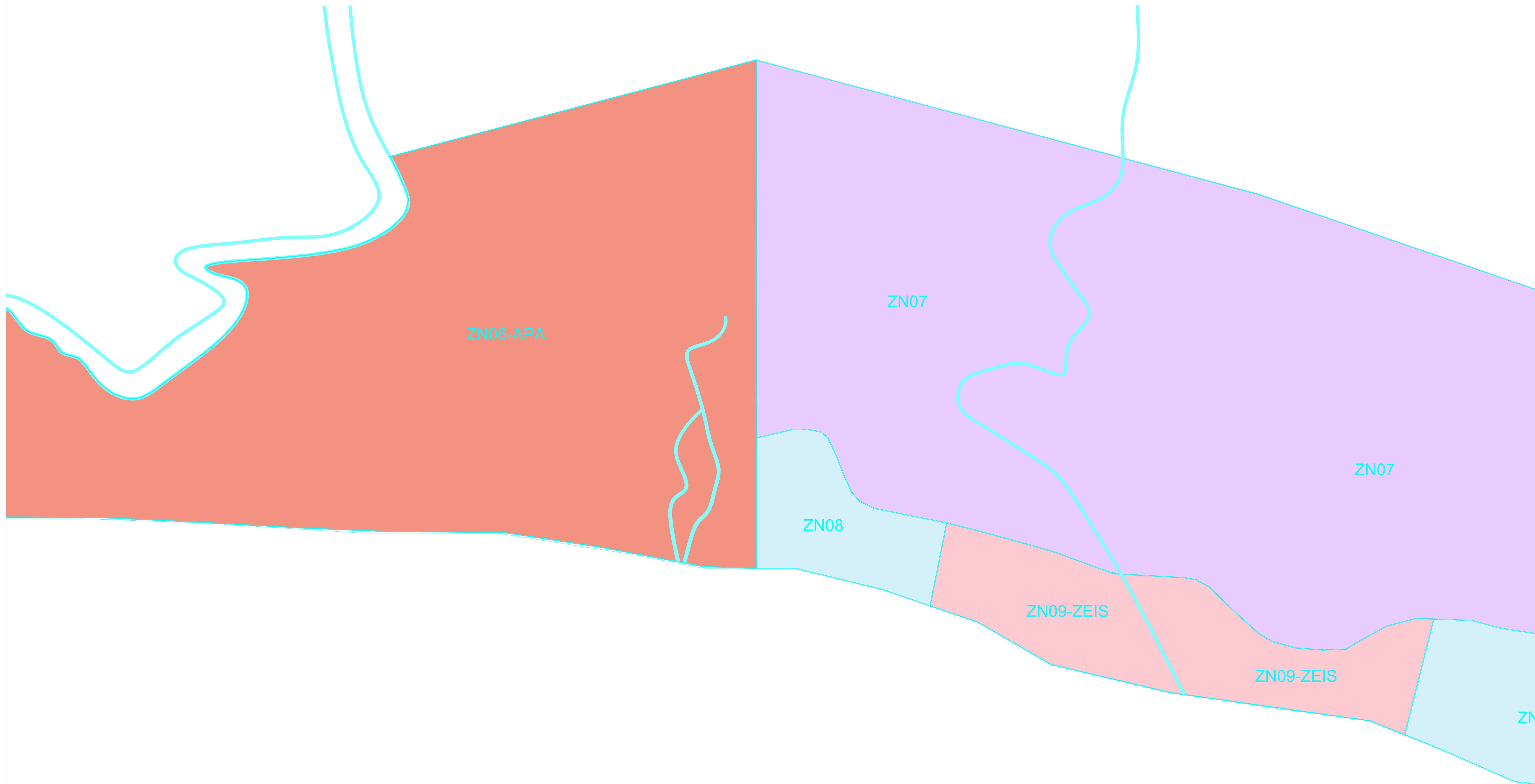
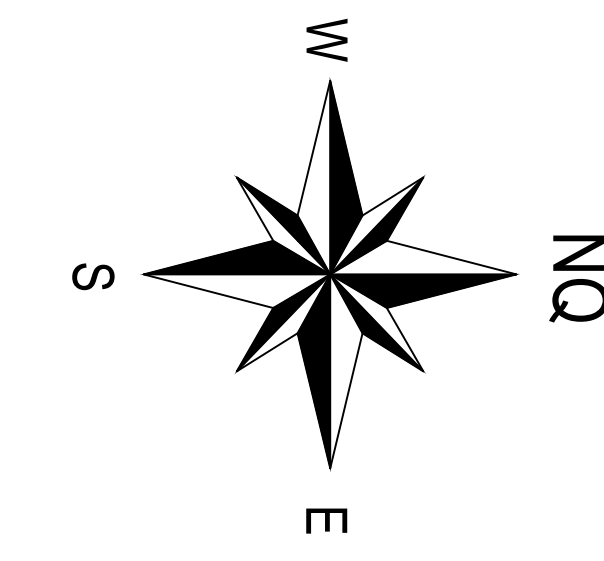

Prefeitura Municipal de Ilhéus

Planta de Zoneamento
Uso e Ocupação do Solo
Anexo I - Lei Nº 3746/2015



ESCALA: 1:10.000 DATA: MAIO 2020 FOLHA:

Secretaria de Meio Ambiente e Urbanismo

02

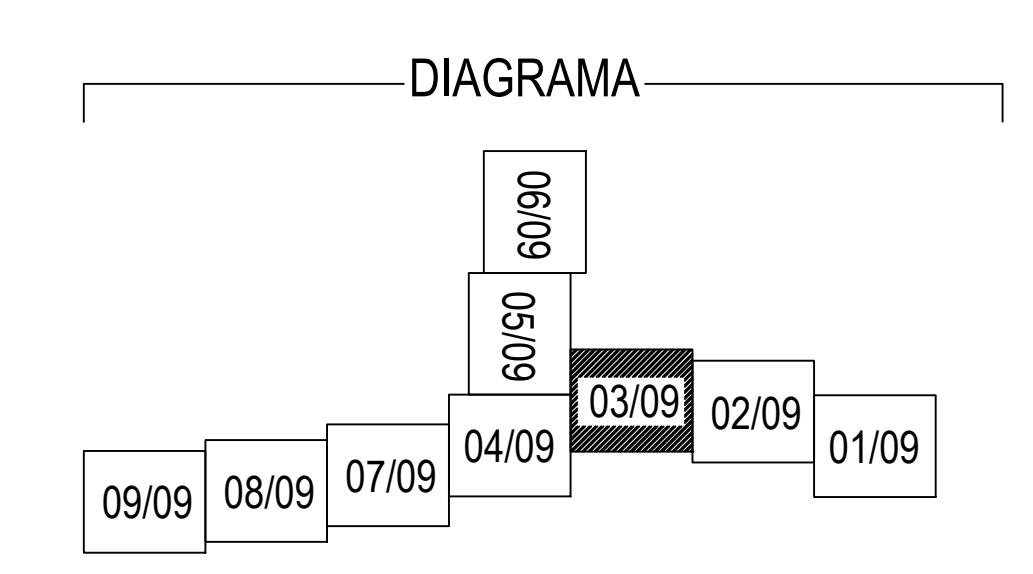
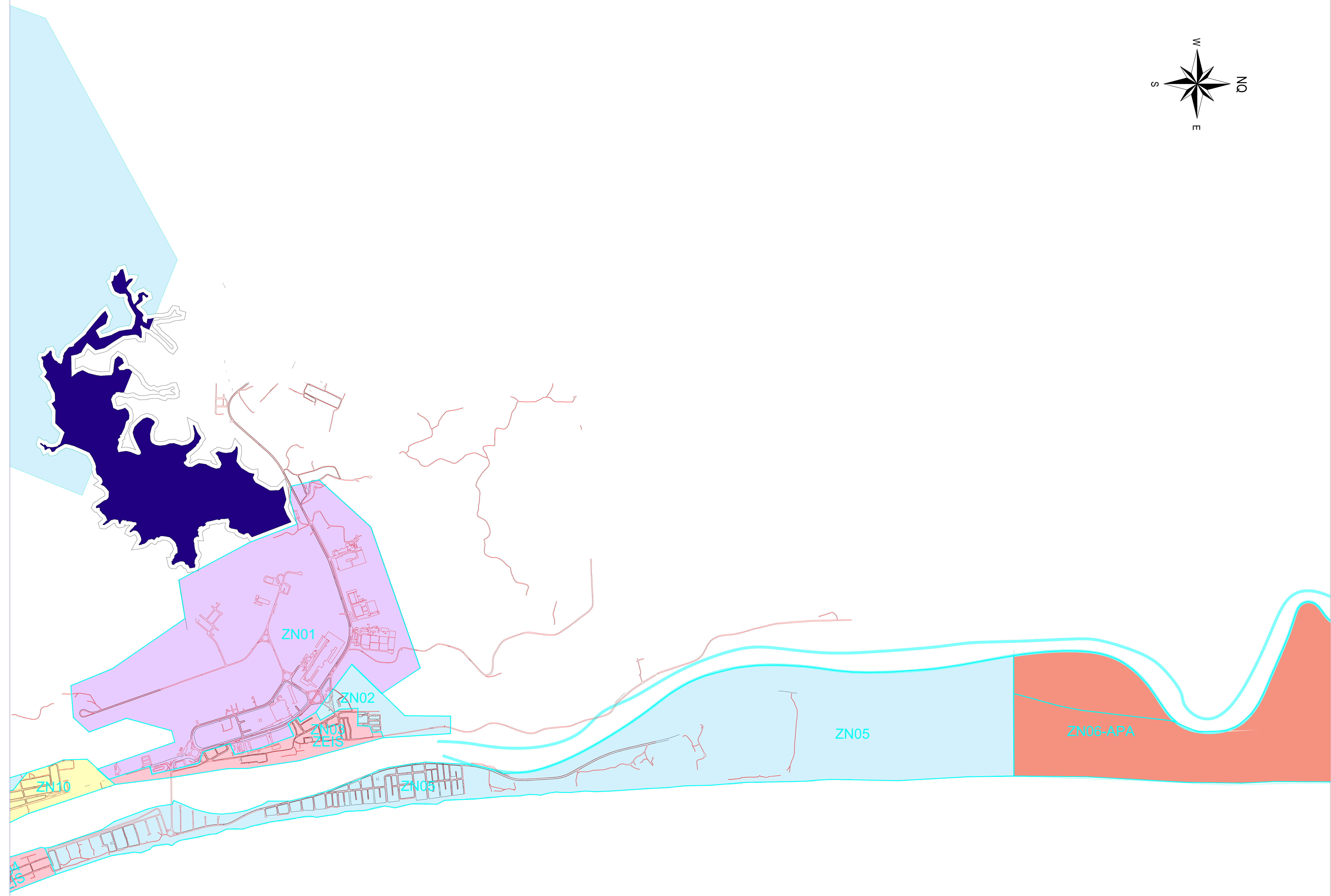
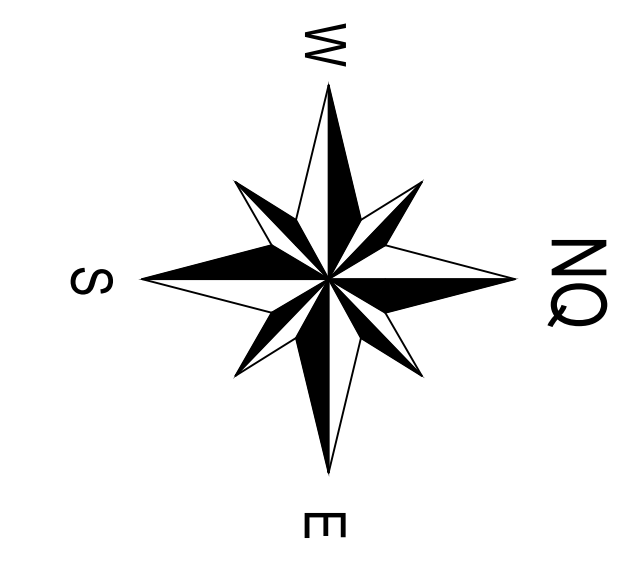

Prefeitura Municipal de Ilhéus

Planta de Zoneamento
Uso e Ocupação do Solo
Anexo I - Lei Nº 3746/2015



ESCALA: 1:10.000 DATA: MAIO 2020 FOLHA:

Secretaria de Meio Ambiente e Urbanismo

03

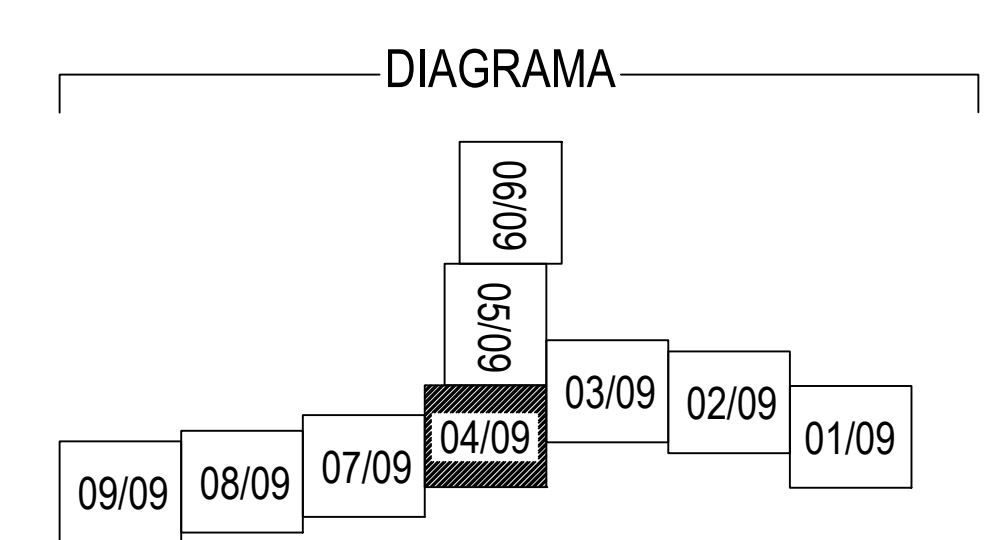
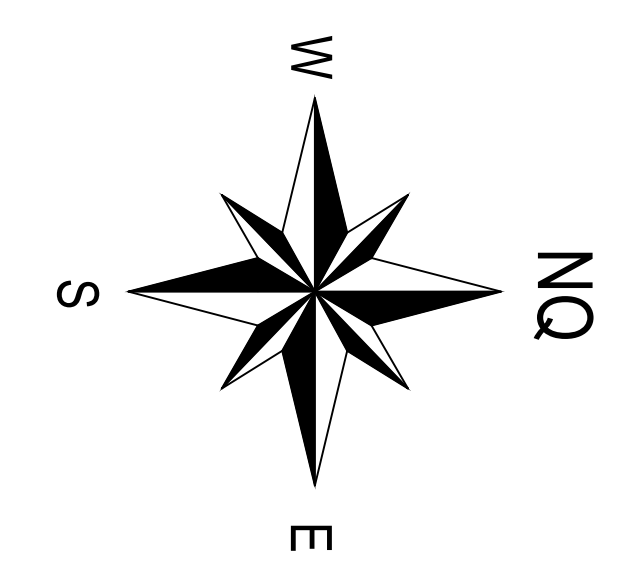
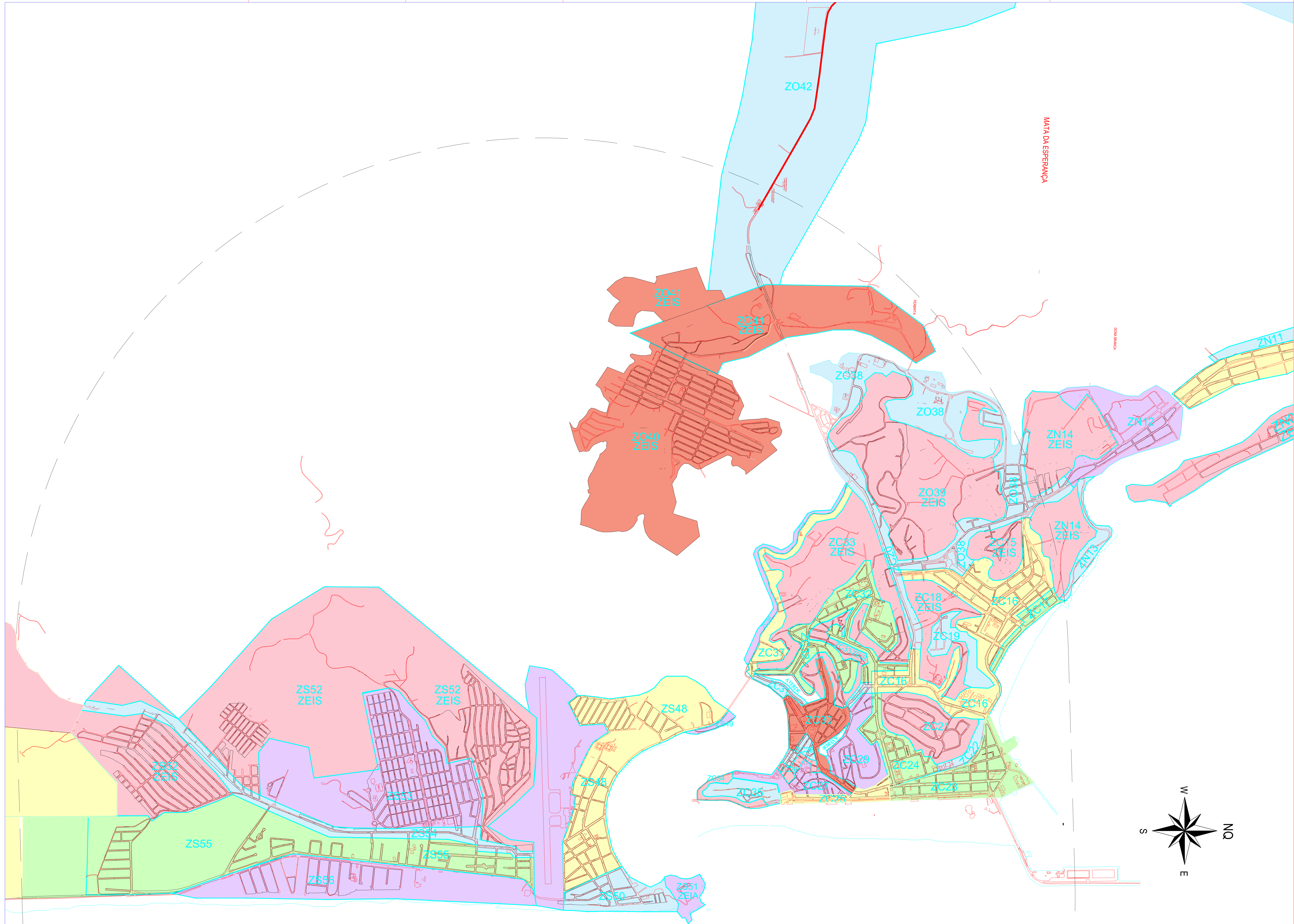

Prefeitura Municipal de Ilhéus

Planta de Zoneamento
 Uso e Ocupação do Solo
 Anexo I - Lei Nº 3746/2015



ESCALA: 1:10.000 DATA: MAIO 2020 FOLHA:

Secretaria de Meio Ambiente e Urbanismo

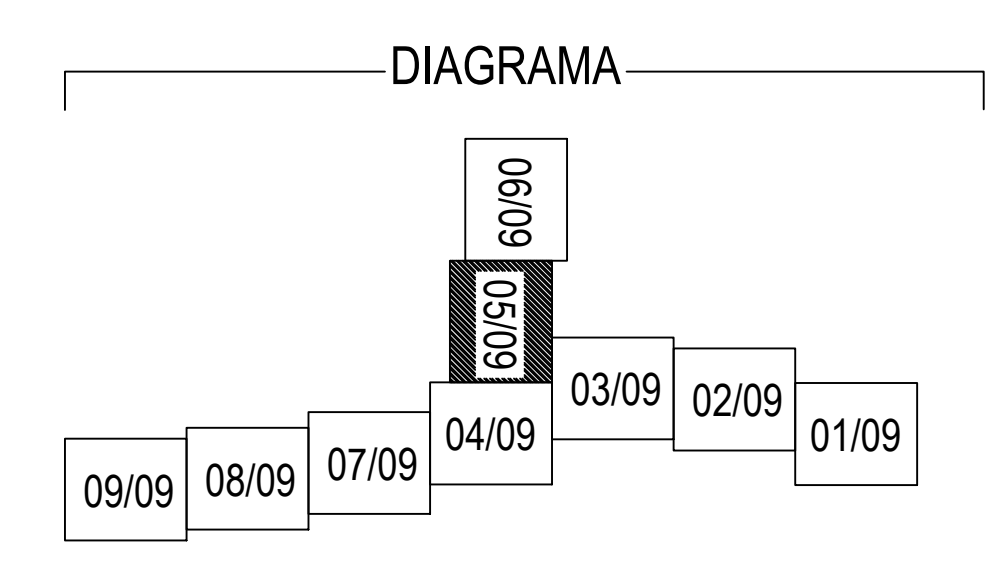
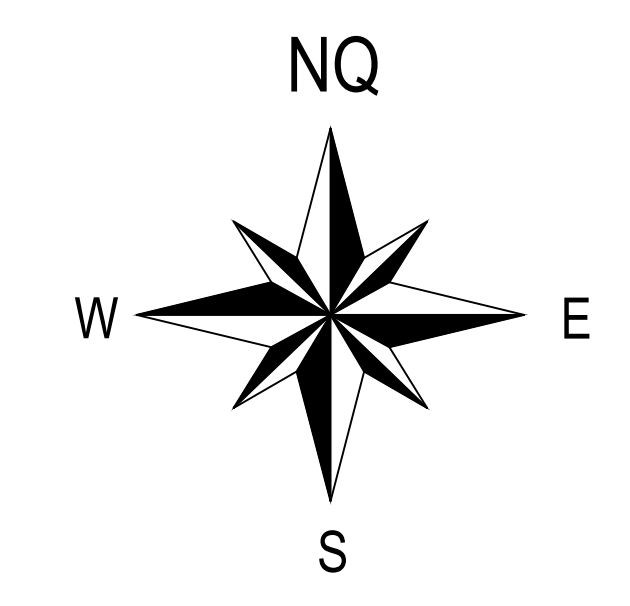
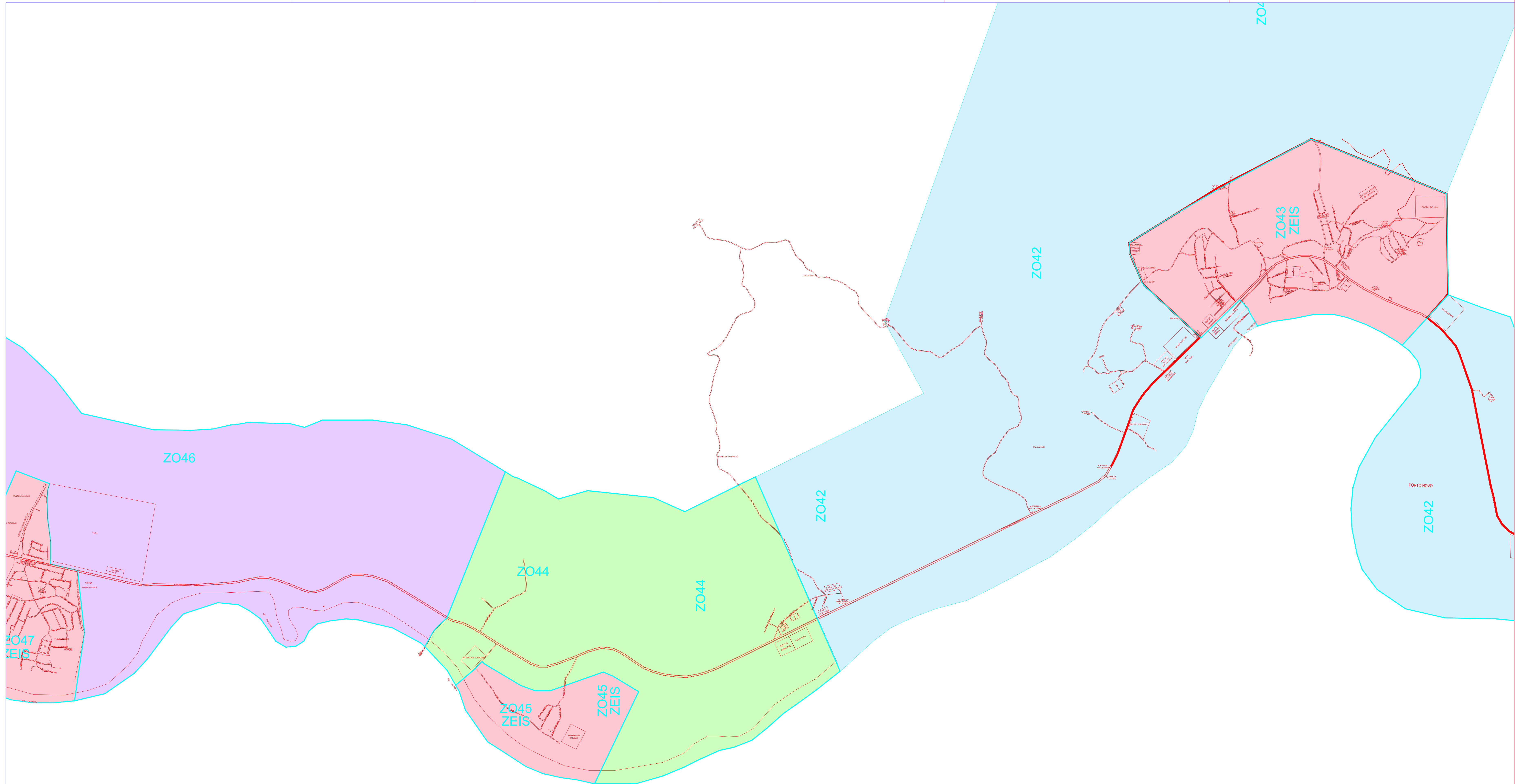

Prefeitura Municipal de Ilhéus

Planta de Zoneamento
 Uso e Ocupação do Solo
 Anexo I - Lei Nº 3746/2015



ESCALA: 1:10.000 DATA: MAIO 2020 FOLHA:

05

Secretaria de Meio Ambiente e Urbanismo

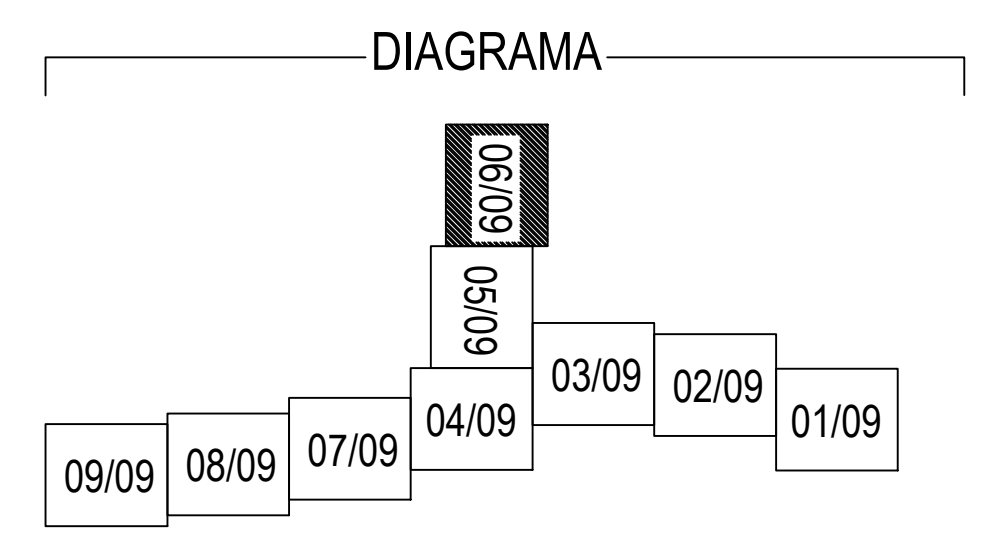
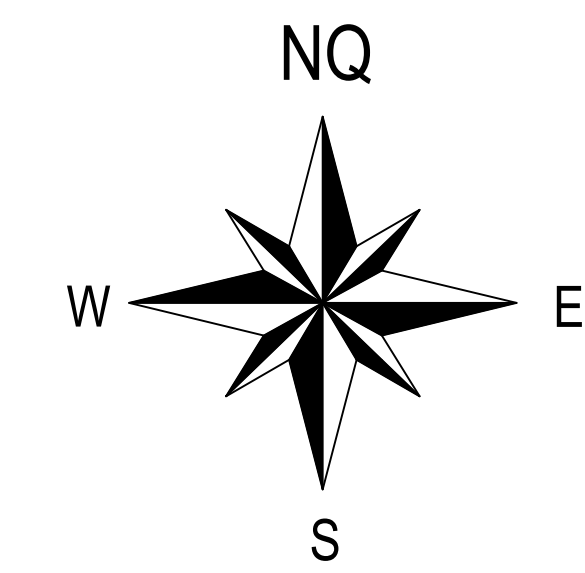
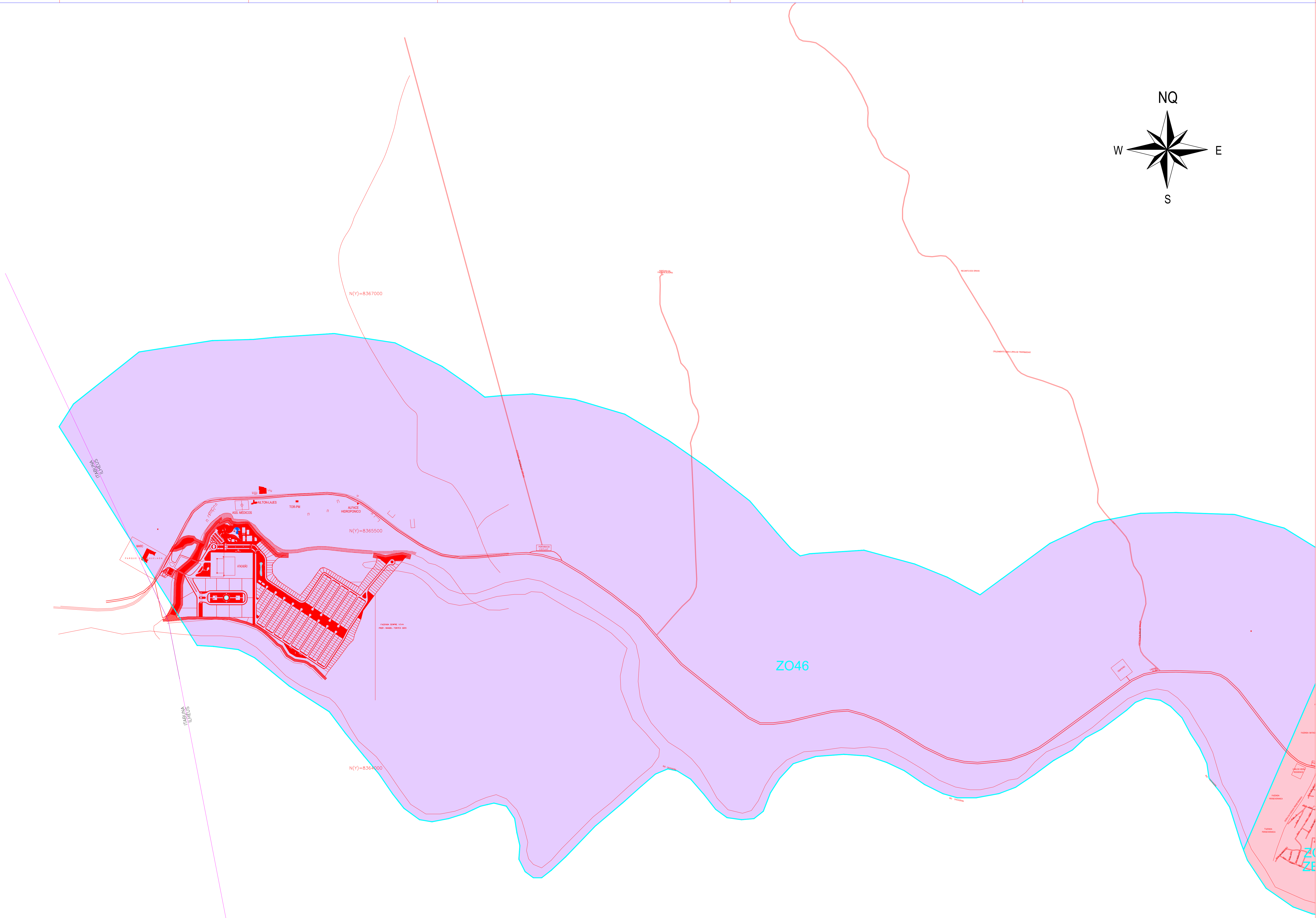

Prefeitura Municipal de Ilhéus

Planta de Zoneamento
Uso e Ocupação do Solo
Anexo I - Lei Nº 3746/2015



ESCALA: 1:10.000 DATA: MAIO 2020 FOLHA:

06

Secretaria de Meio Ambiente e Urbanismo

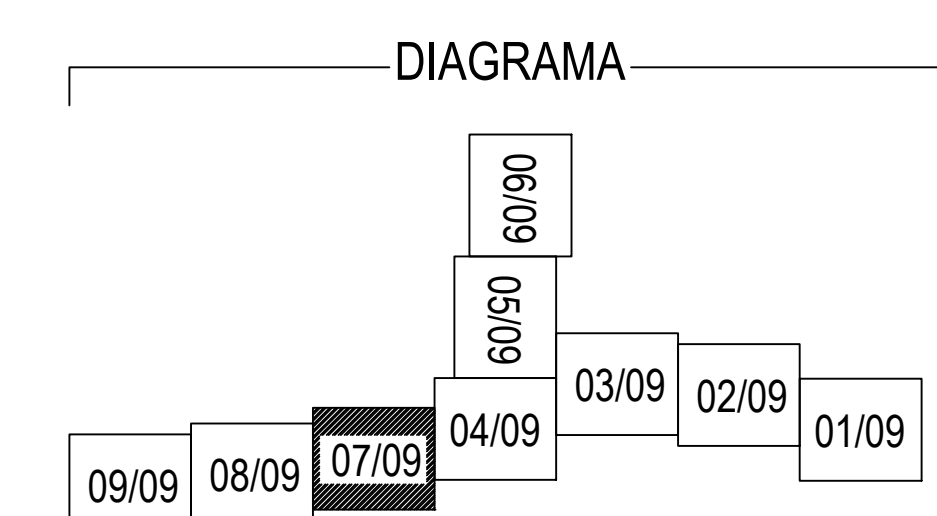
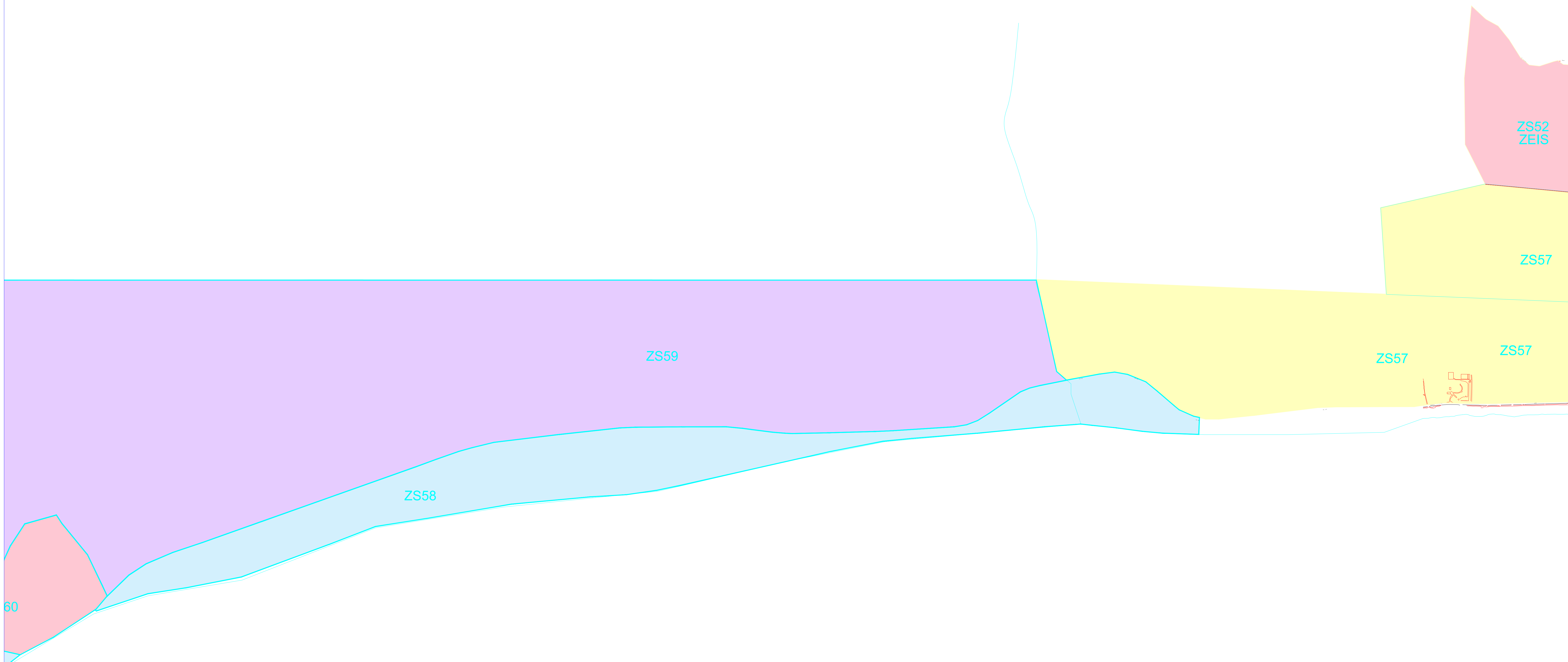
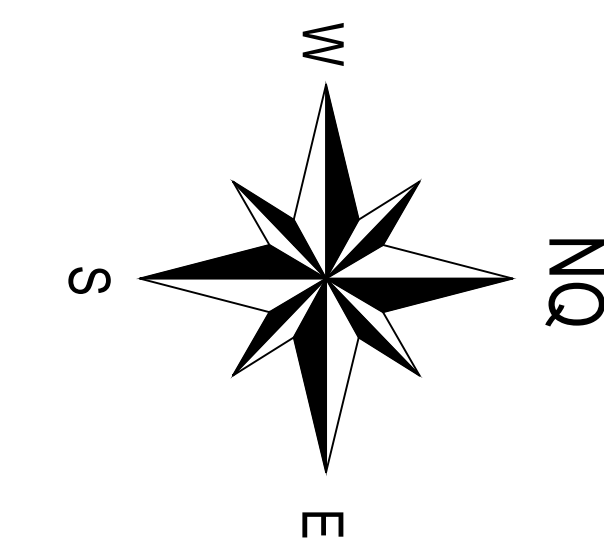

Prefeitura Municipal de Ilhéus

Planta de Zoneamento
Uso e Ocupação do Solo
Anexo I - Lei Nº 3746/2015



ESCALA: 1:10.000 DATA: MAIO 2020 FOLHA:
Secretaria de Meio Ambiente e Urbanismo

07

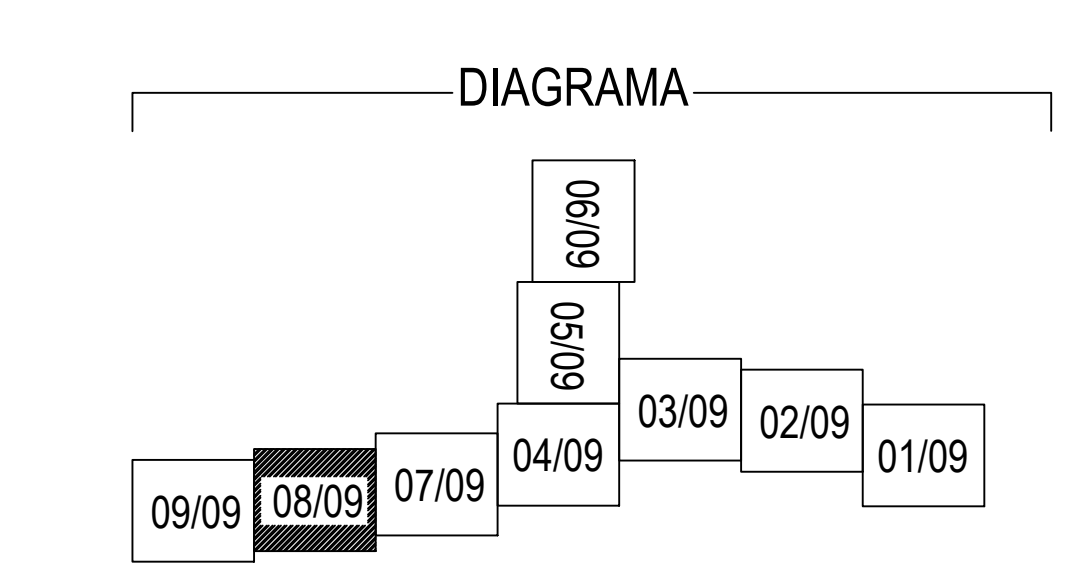
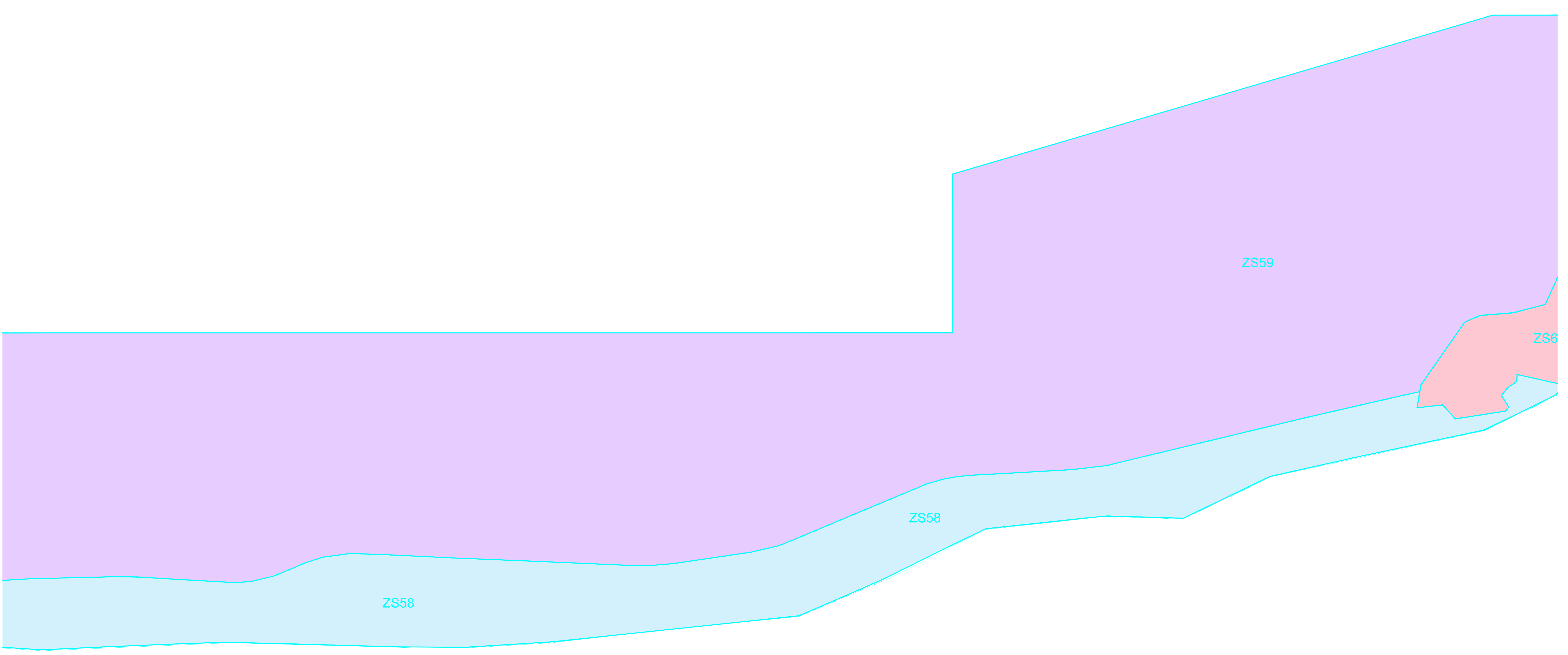
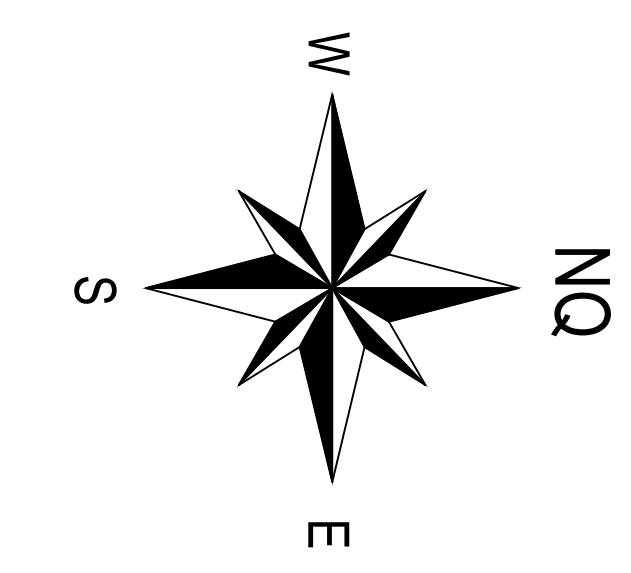

Prefeitura Municipal de Ilhéus

Planta de Zoneamento
Uso e Ocupação do Solo
Anexo I - Lei Nº 3746/2015



ESCALA: 1:10.000 DATA: MAIO 2020 FOLHA:

Secretaria de Meio Ambiente e Urbanismo

08

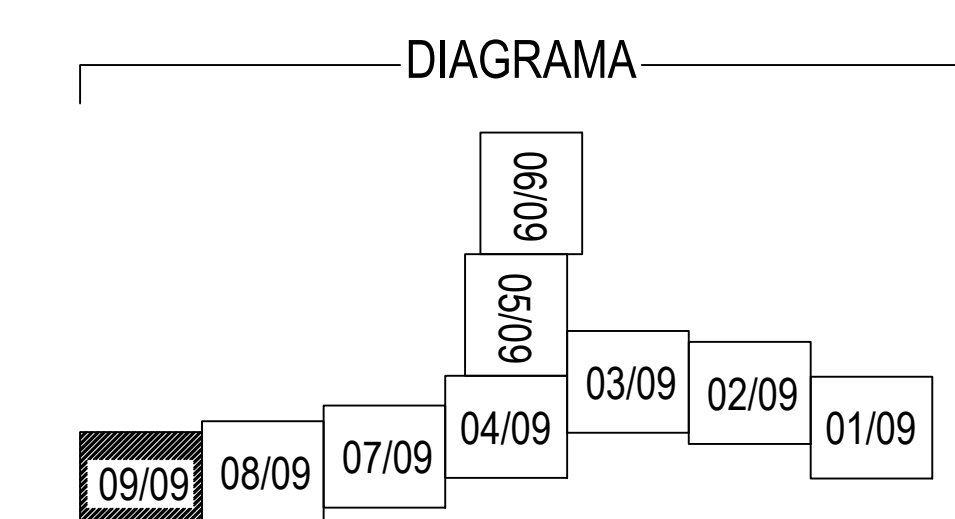
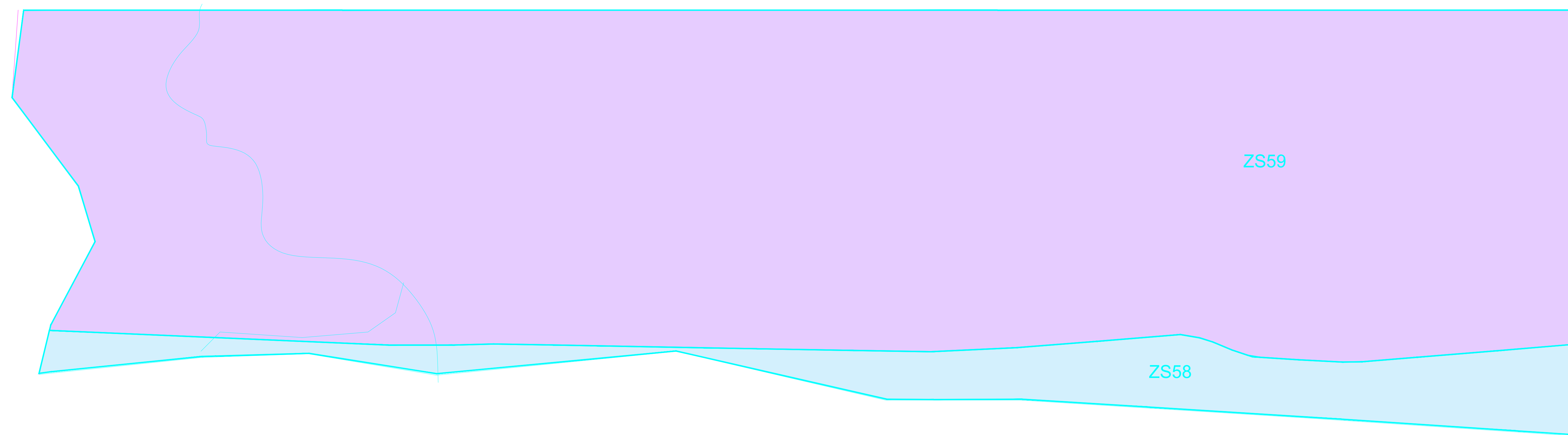
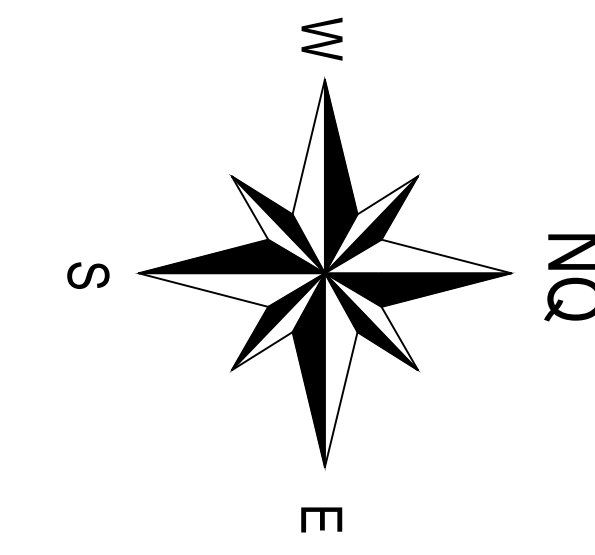

Prefeitura Municipal de Ilhéus

Planta de Zoneamento
Uso e Ocupação do Solo
Anexo I - Lei Nº 3746/2015



ESCALA: 1:10.000 DATA: MAIO 2020 FOLHA:

Secretaria de Meio Ambiente e Urbanismo

09

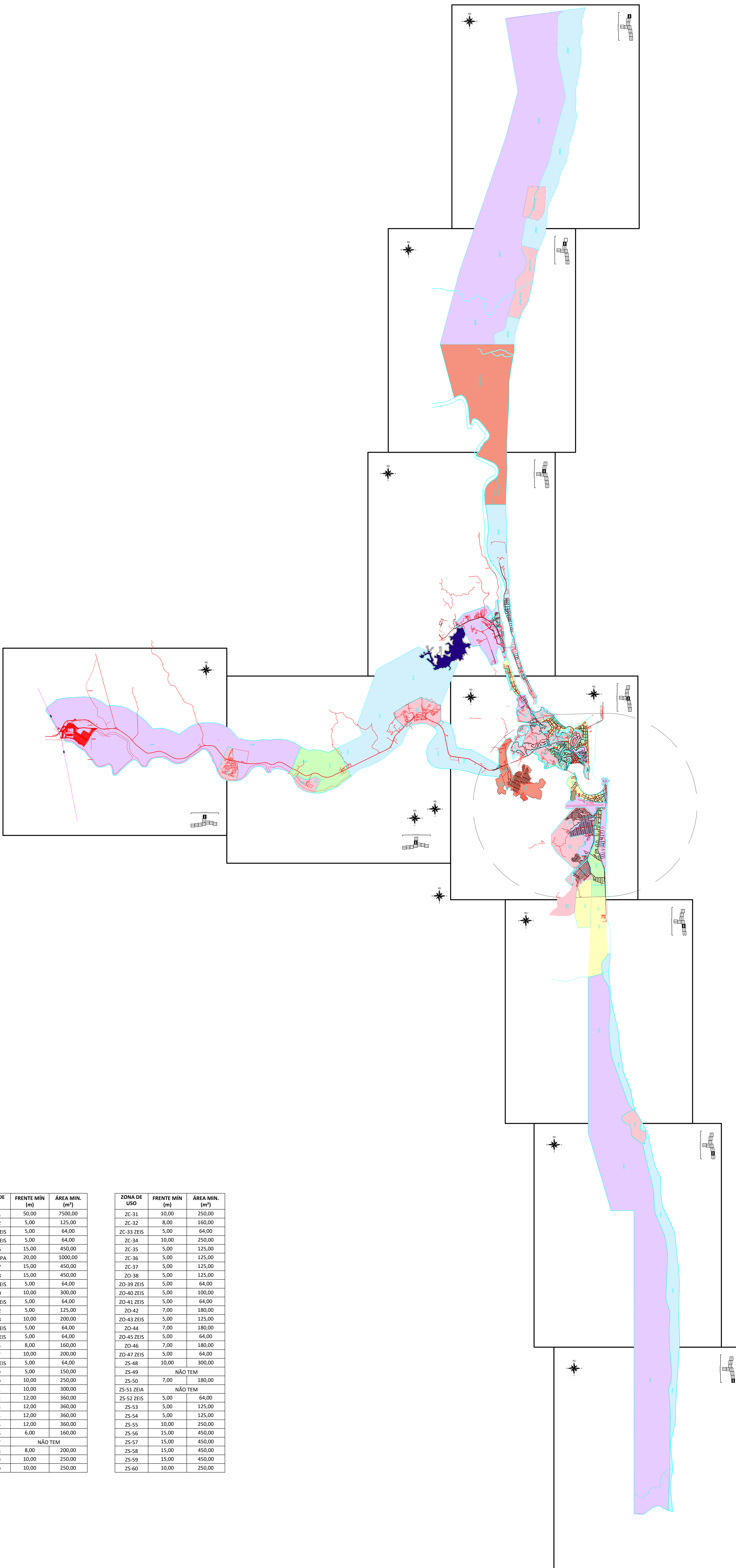

ZONA DE USO	FRENTE MÍN (m)	ÁREA MÍN. (m²)
ZN-01	50,00	7500,00
ZN-02	5,00	125,00
ZN-03 ZEIS	5,00	64,00
ZN-04 ZEIS	5,00	64,00
ZN-05	15,00	450,00
ZN-06 APA	20,00	1000,00
ZN-07	15,00	450,00
ZN-08	15,00	450,00
ZN-09 ZEIS	5,00	64,00
ZN-10	10,00	300,00
ZN-11 ZEIS	5,00	64,00
ZN-12	5,00	125,00
ZN-13	10,00	200,00
ZN-14 ZEIS	5,00	64,00
ZC-15 ZEIS	5,00	64,00
ZC-16	8,00	160,00
ZC-17	10,00	200,00
ZC-18 ZEIS	5,00	64,00
ZC-19	5,00	150,00
ZC-20	10,00	250,00
ZC-21	10,00	300,00
ZC-22	12,00	360,00
ZC-23	12,00	360,00
ZC-24	12,00	360,00
ZC-25	12,00	360,00
ZC-26	6,00	160,00
ZC-27	NÃO TEM	
ZC-28	8,00	200,00
ZC-29	10,00	250,00
ZC-30	10,00	250,00

ZONA DE USO	FRENTE MÍN (m)	ÁREA MÍN. (m²)
ZC-31	10,00	250,00
ZC-32	8,00	160,00
ZC-33 ZEIS	5,00	64,00
ZC-34	10,00	250,00
ZC-35	5,00	125,00
ZC-36	5,00	125,00
ZC-37	5,00	125,00
ZO-38	5,00	125,00
ZO-39 ZEIS	5,00	64,00
ZO-40 ZEIS	5,00	100,00
ZO-41 ZEIS	5,00	64,00
ZO-42	7,00	180,00
ZO-43 ZEIS	5,00	125,00
ZO-44	7,00	180,00
ZO-45 ZEIS	5,00	64,00
ZO-46	7,00	180,00
ZO-47 ZEIS	5,00	64,00
ZS-48	10,00	300,00
ZS-49	NÃO TEM	
ZS-50	7,00	180,00
ZS-51 ZEIA	NÃO TEM	
ZS-52 ZEIS	5,00	64,00
ZS-53	5,00	125,00
ZS-54	5,00	125,00
ZS-55	10,00	250,00
ZS-56	15,00	450,00
ZS-57	15,00	450,00
ZS-58	15,00	450,00
ZS-59	15,00	450,00
ZS-60	10,00	250,00